

MOD_20_21 and other undo scenarios

**Changes to Appendix O for Instruction Profiling and Bid Offer
Acceptance Quantity Outcomes in a Subset of Undo Scenarios**

Katia Compagnoni
02nd December 2021

Subset of Undo Scenarios - Background

- In four scenarios, expected to be relatively rare, the outcome in the system is different to that in rules;
- They refer to undo dispatch actions in Instruction Profiling, originally considered defects, but now classed as changes;
- The SEMC decision on Mod_27_18 requires SEMO to correct those non-compliances by fixing the systems;
- The vendor's recent high level impact assessment states that each change is deemed very high cost and very high risk and will need individual detailed assessments;
- SEMO is proposing to request detailed impact assessments for three scenarios (two of which grouped) while changing the T&SC for scenario 2.

Subset of Undo Scenarios - Summary

- Scenario 1 **'SYNC with MWOFF undo to level below MSG before reaching MSG'**
- Change to the system pending detailed impact assessment (grouped with Scenario 4):
 - 7 cases identified since Oct 2019 – 1 in 2019, 3 in 2020 and 3 in 2021
 - one case of high materiality (approx. 800K) in 2020 all others low materiality but 2 unknown due to no IP profile
- Scenario 2 **'SYNC with DESY after MSG but before reaching Min On Time'**
- Modification to the Code (Mod_20_21) to align with the system:
 - No cases identified since go live – not material
- **Scenario 3 'DESY with SYNC after reaching zero before Min Off Time'**
- Change to the system pending detailed Impact assessment:
 - 7 cases identified since go live - 1 in 2018, 1 in 2019, and 5 in 2021
 - Materiality vary from >100€ to approximately 200K
- Scenario 4 **'SYNC with DESY before reaching MSG'**
- Change to the system pending detailed impact assessment (grouped with Scenario 1):
 - 2 case identified in 2018 and none since
 - Materiality of 190K and 580K

Subset of Undo Scenarios - Summary

- Scenario 1 **'SYNC with MWOFF undo to level below MSG before reaching MSG'**
- Change to the system pending detailed impact assessment (grouped with Scenario 4):
 - 7 cases identified since Oct 2019 – 1 in 2019, 3 in 2020 and 3 in 2021
 - one case of high materiality (approx. 800K) in 2020 all others low materiality but 2 unknown due to no IP profile
- Scenario 2 **'SYNC with DESY after MSG but before reaching Min On Time'**
- Modification to the Code(Mod_20_21) to align with the system:
 - No cases identified since go live – not material
- Scenario 3 **'DESY with SYNC after reaching zero before Min Off Time'**
- Change to the system pending detailed Impact assessment:
 - 7 cases identified since go live - 1 in 2018, 1 in 2019, and 5 in 2021
 - Materiality vary from >100€ to approximately 200K
- Scenario 4 **'SYNC with DESY before reaching MSG'**
- Change to the system pending detailed impact assessment (grouped with Scenario 1):
 - 2 case identified in 2018 and none since
 - Materiality of 190K and 580K

Scenario 1 – Intention of rules

SYNC to MSG with subsequent MWOFF below MSG before reaching MSG

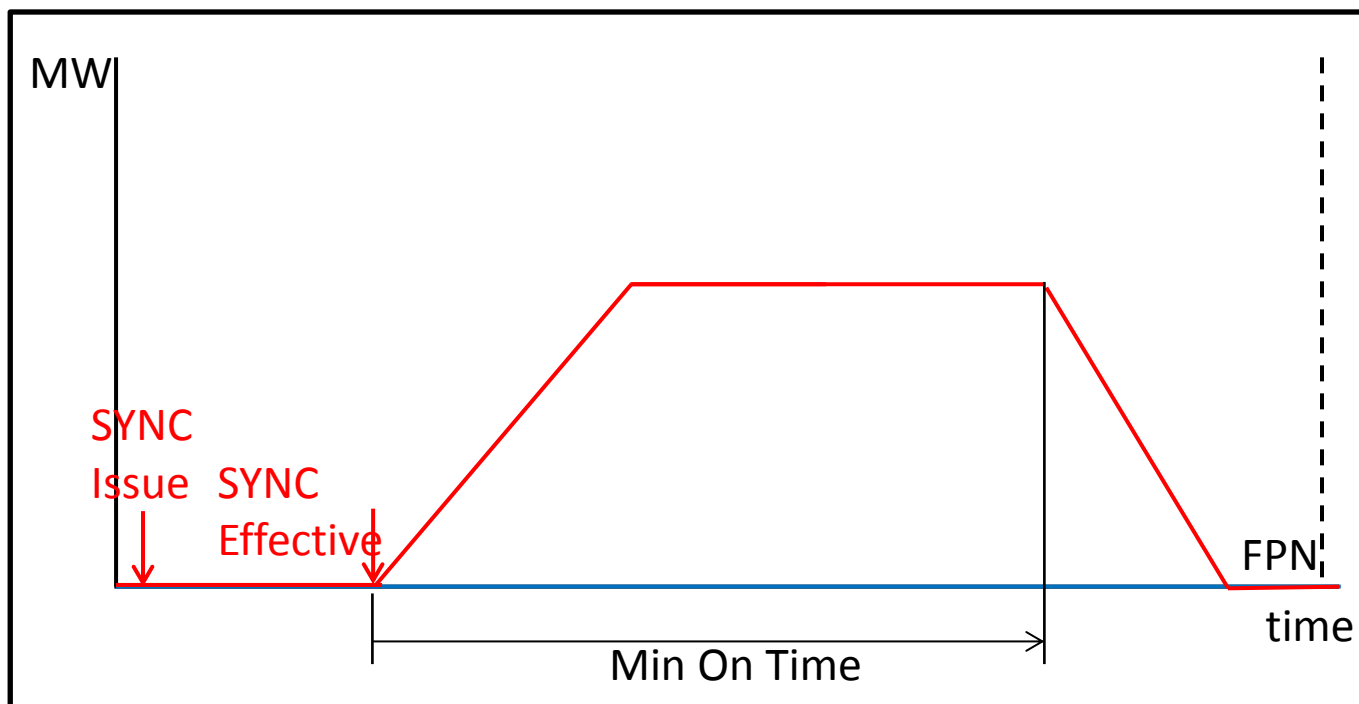

Scenario 1 – Intention of rules

SYNC to MSG with subsequent MWOFF below MSG before reaching MSG

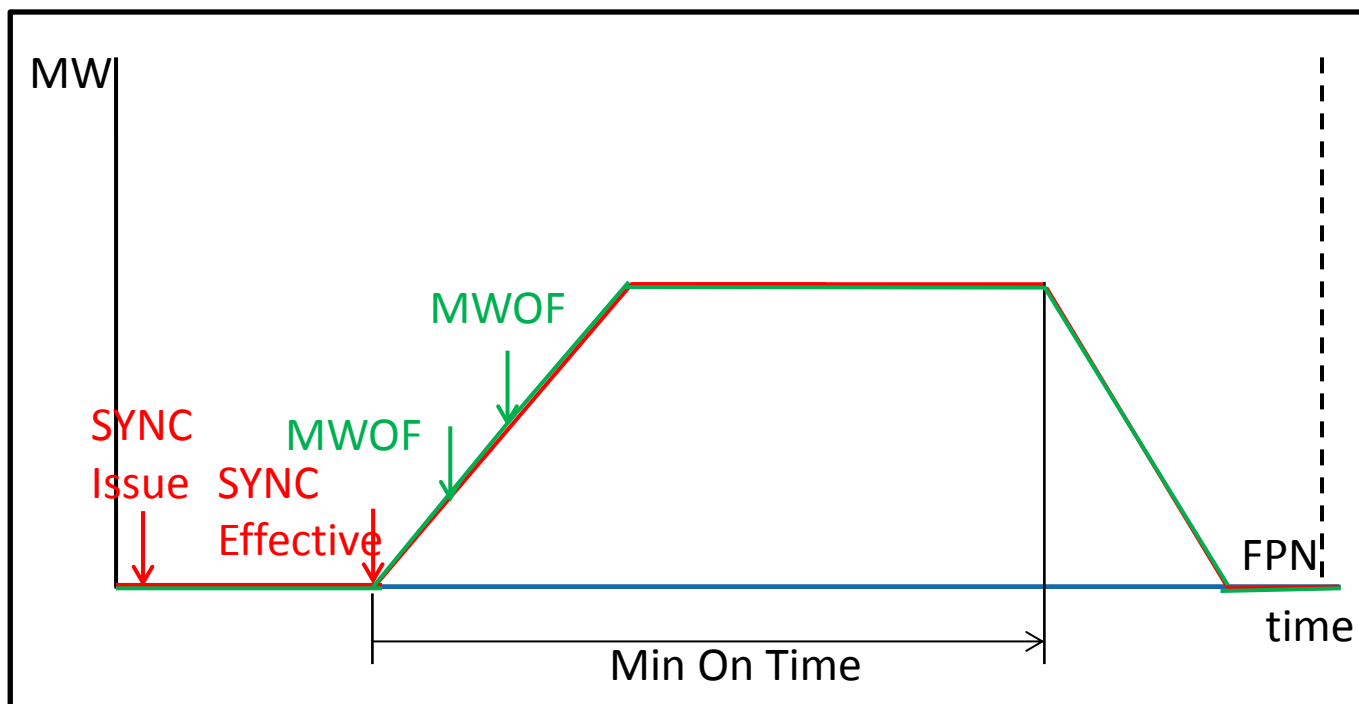

Scenario 1 – Intention of rules

SYNC to MSG with subsequent MWOFF below MSG before reaching MSG

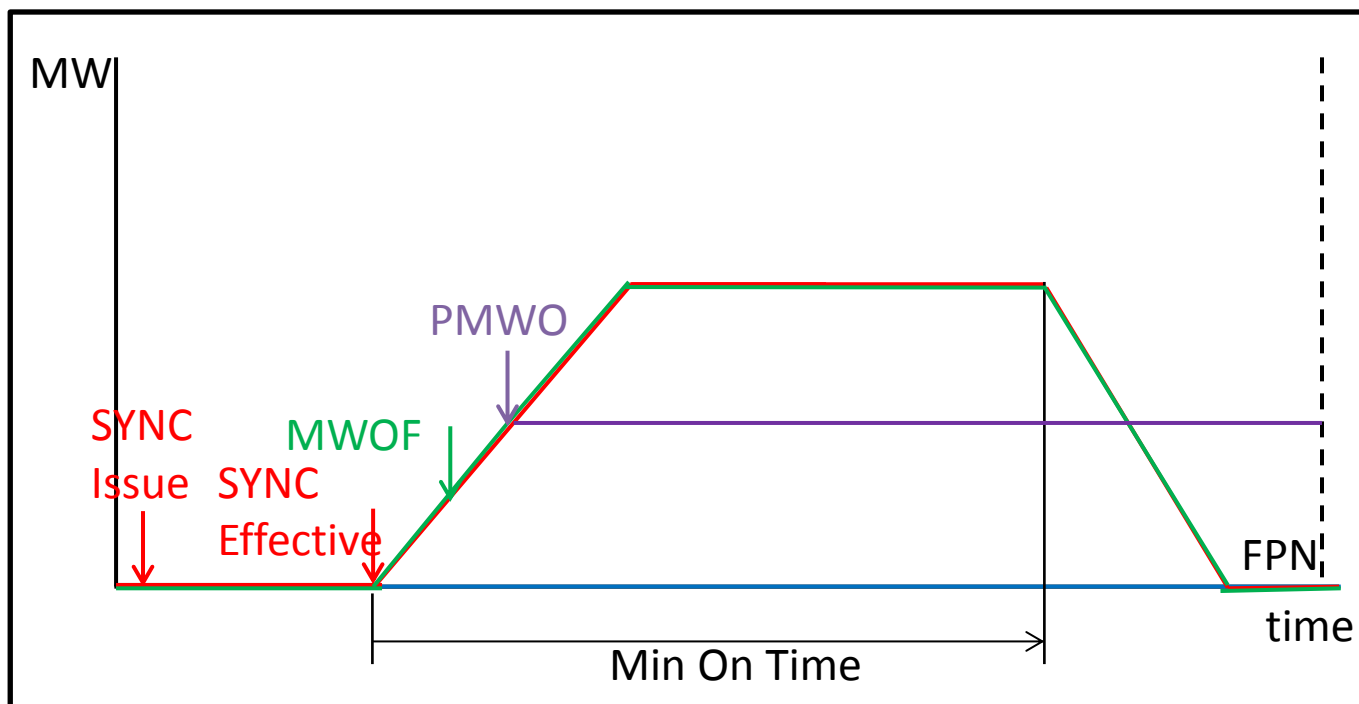

Scenario 1 – Happening in systems

SYNC to MSG with subsequent MWOFF below MSG before reaching MSG

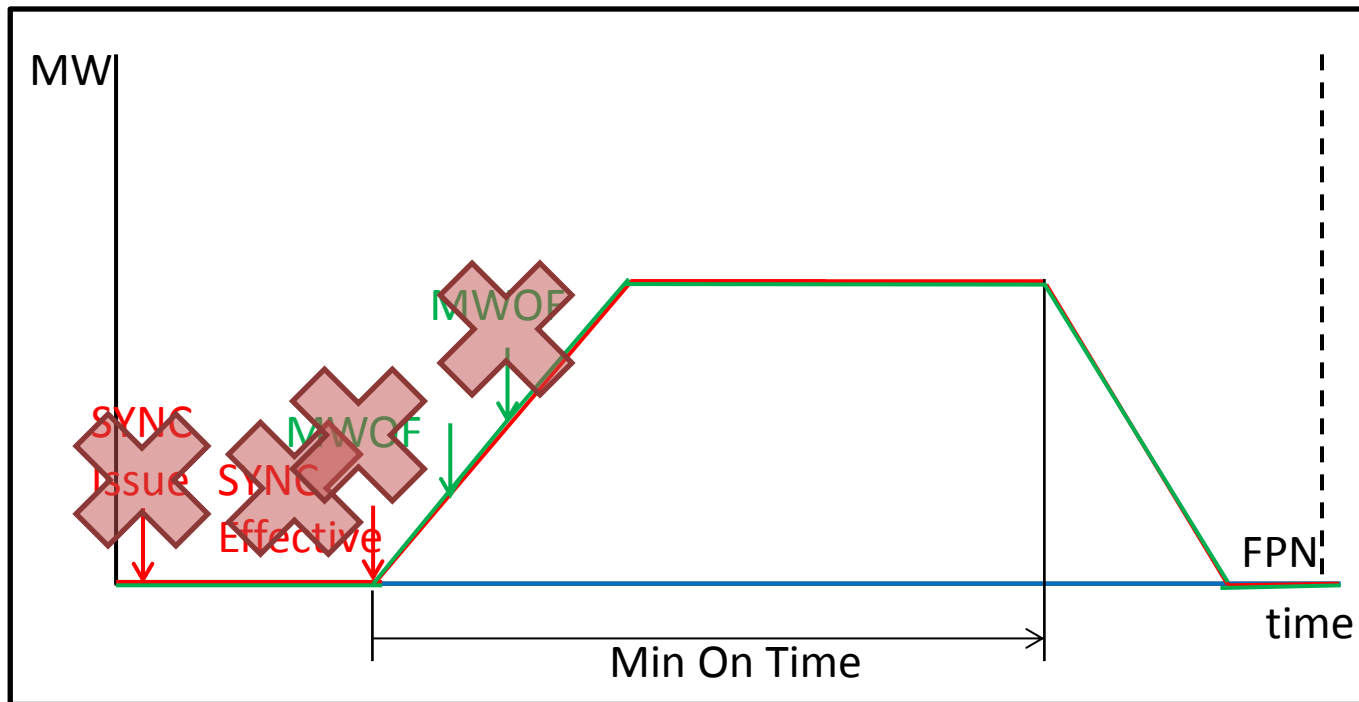

Scenario 1 – Impacted area

SYNC to MSG with subsequent MWOF below MSG before reaching MSG

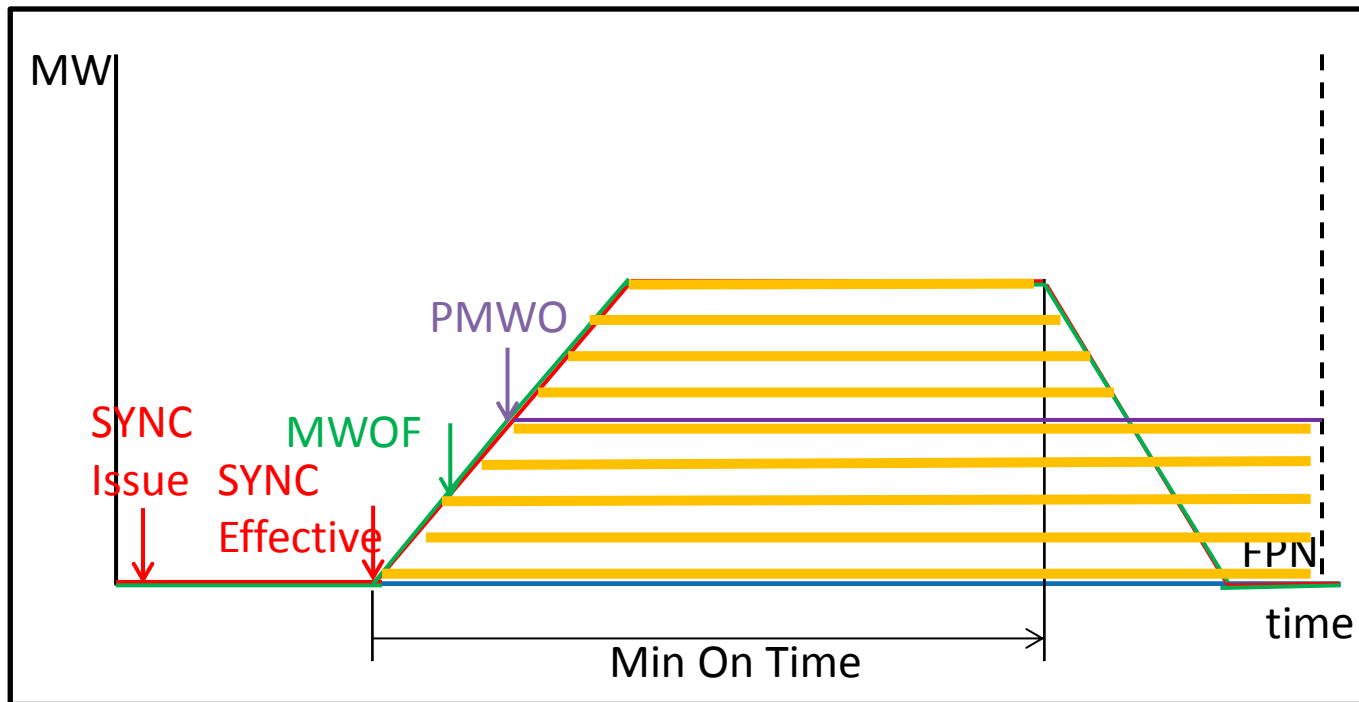

Profile will return to 'normal' with a MWOF > MSG following the heat state at the time of the new MWOF

Scenario 4 – Intention of rules

SYNC and DESY before MSG

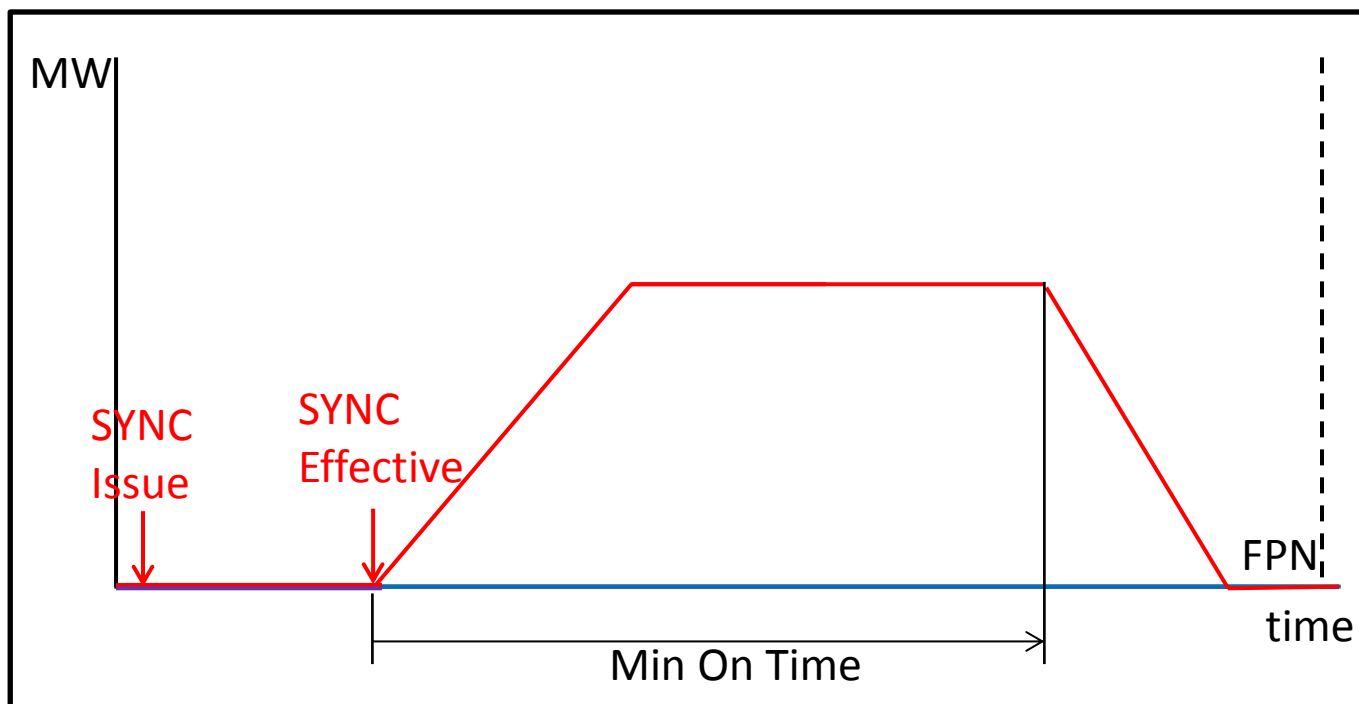

Scenario 4 – Intention of rules

SYNC and DESY before MSG

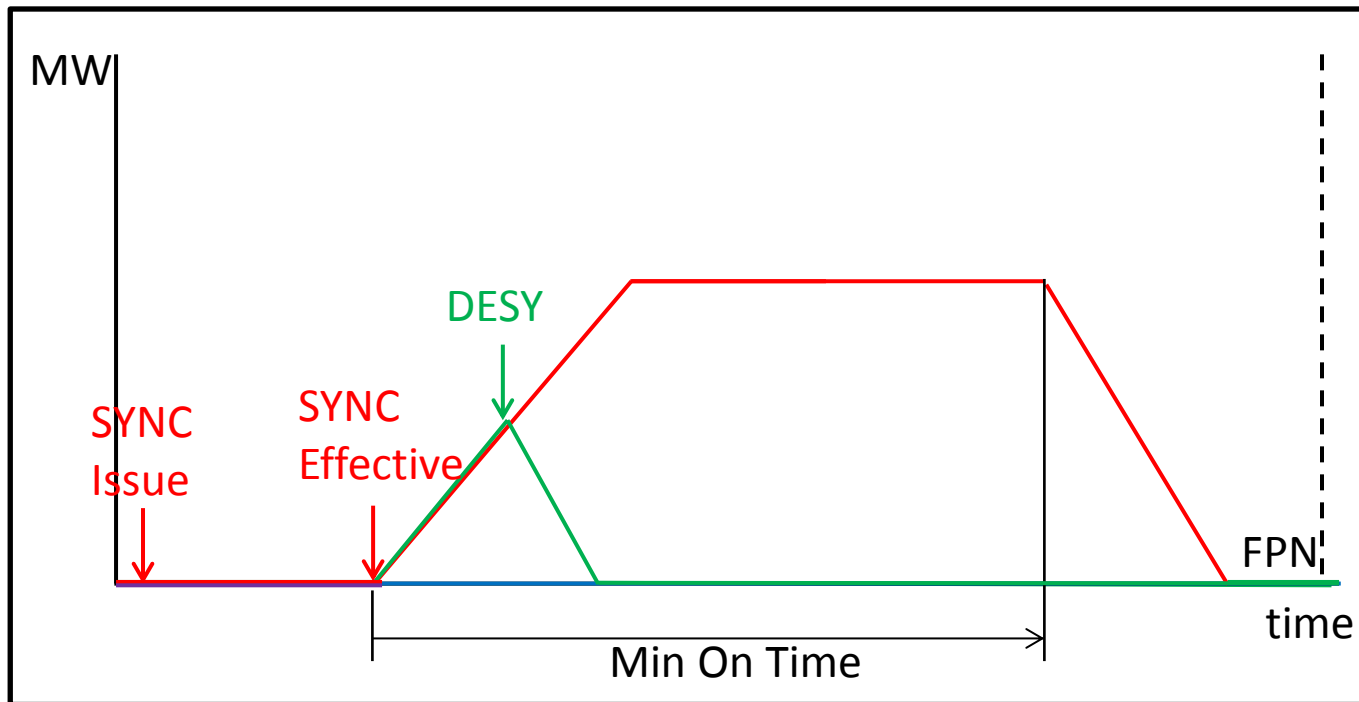

Scenario 4 – Intention of rules

SYNC and DESY before MSG

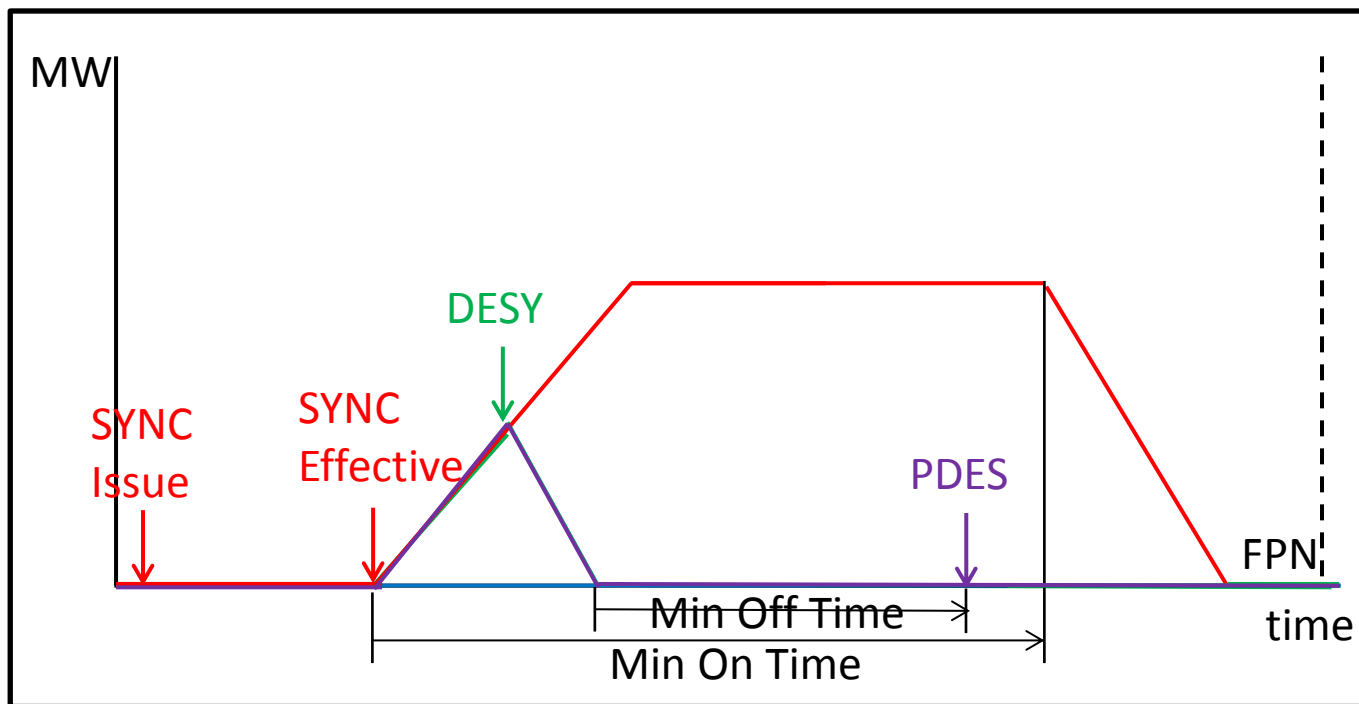

Scenario 4 – Happening in systems

SYNC and DESY before MSG

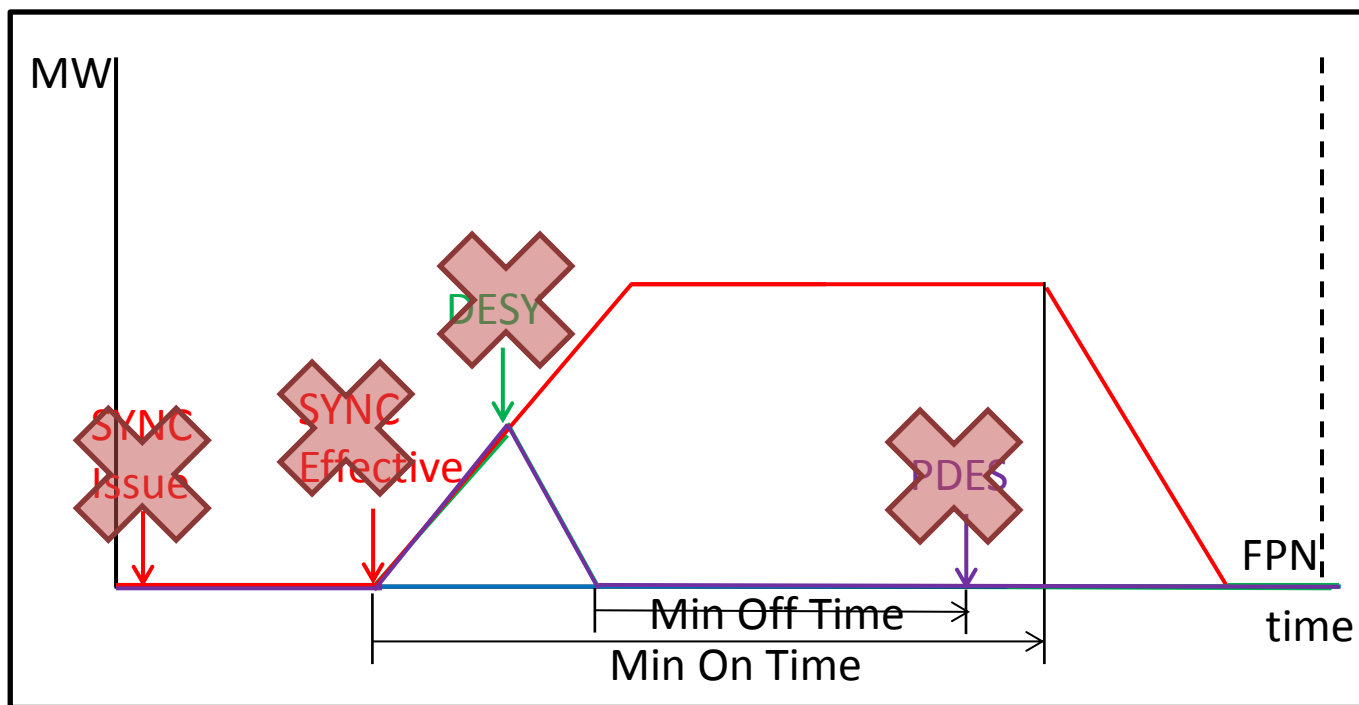

Scenario 4 – Impacted area

SYNC and DESY before MSG

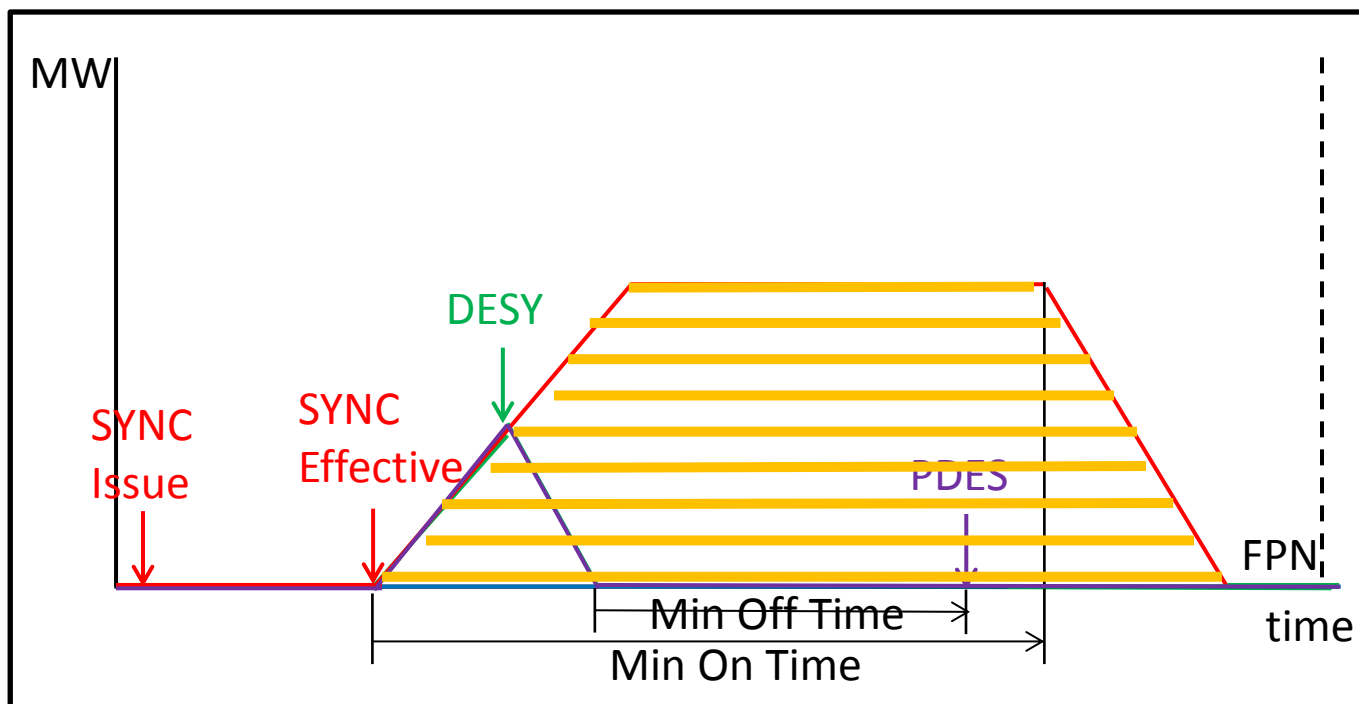

Subset of Undo Scenarios - Summary

- Scenario 1 '**SYNC with MWOFF undo to level below MSG before reaching MSG**'
- Change to the system pending detailed impact assessment (grouped with Scenario 4):
 - 7 cases identified since Oct 2019 – 1 in 2019, 3 in 2020 and 3 in 2021
 - one case of high materiality (approx. 800K) in 2020 all others low materiality but 2 unknown due to no IP profile
- Scenario 2 '**SYNC with DESY after MSG but before reaching Min On Time**'
- Modification to the Code (Mod_20_21) to align with the system:
 - No cases identified since go live – not material
- Scenario 3 '**DESY with SYNC after reaching zero before Min Off Time**'
- Change to the system pending detailed Impact assessment:
 - 7 cases identified since go live - 1 in 2018, 1 in 2019, and 5 in 2021
 - Materiality vary from >100€ to approximately 200K
- Scenario 4 '**SYNC with DESY before reaching MSG**'
- Change to the system pending detailed impact assessment (grouped with Scenario 1):
 - 2 case identified in 2018 and none since
 - Materiality of 190K and 580K

Scenario 2 – Intention of rules

SYNC and DESY after MSG before Min On Time

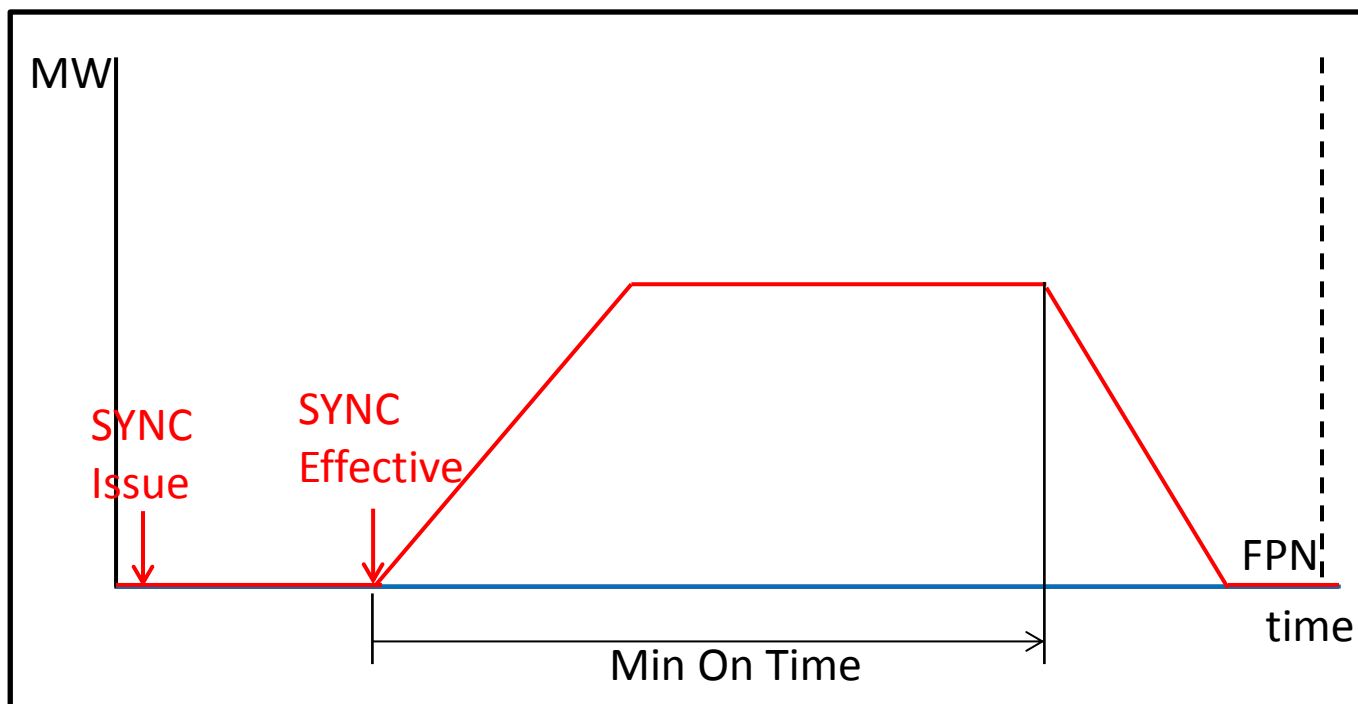

Scenario 2 – Intention of rules

SYNC and DESY after MSG before Min On Time

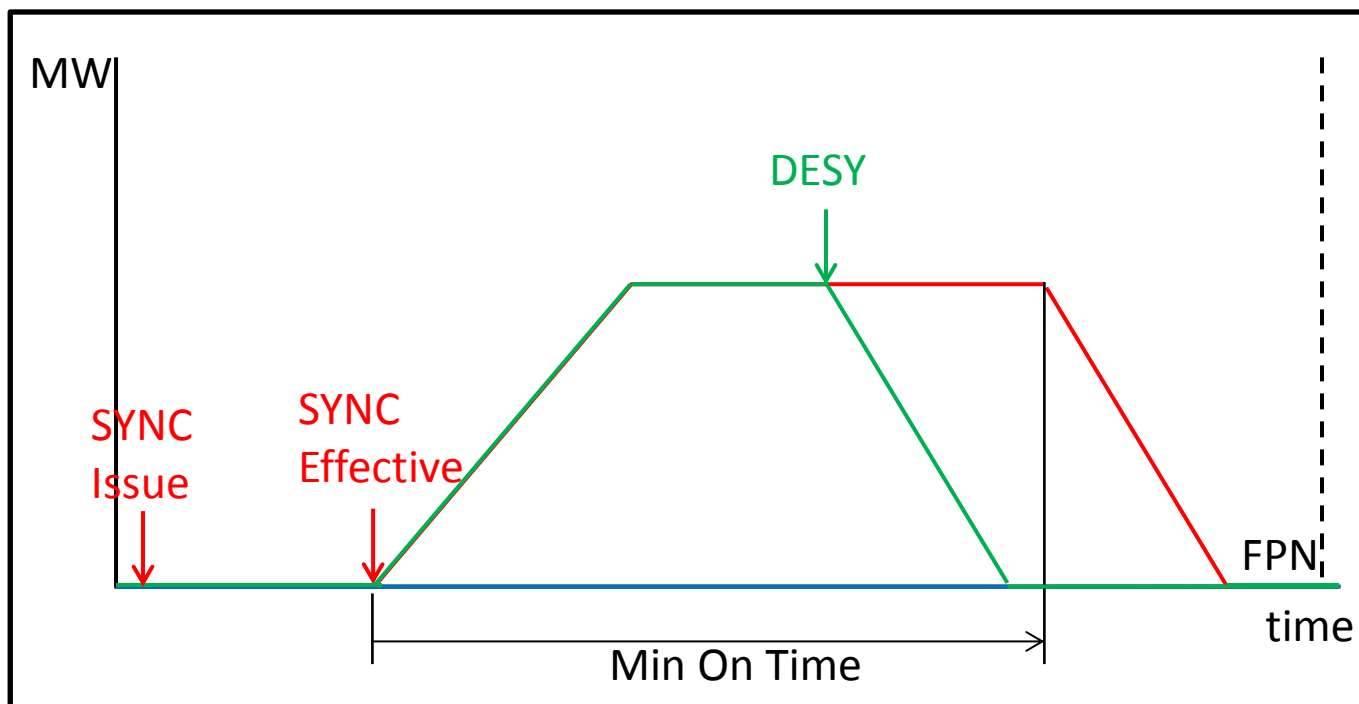

Scenario 2 – Intention of rules

SYNC and DESY after MSG before Min On Time

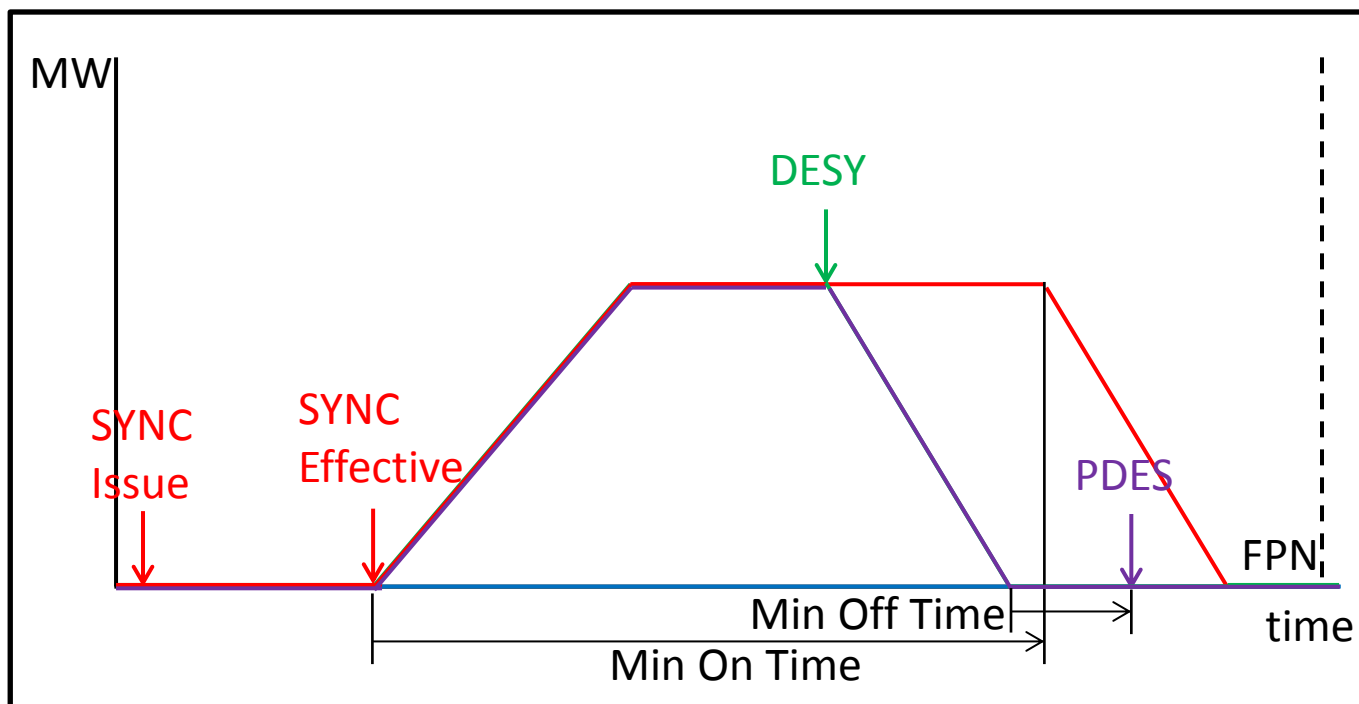

Scenario 2 – Happening in systems

SYNC and DESY after MSG before Min On Time

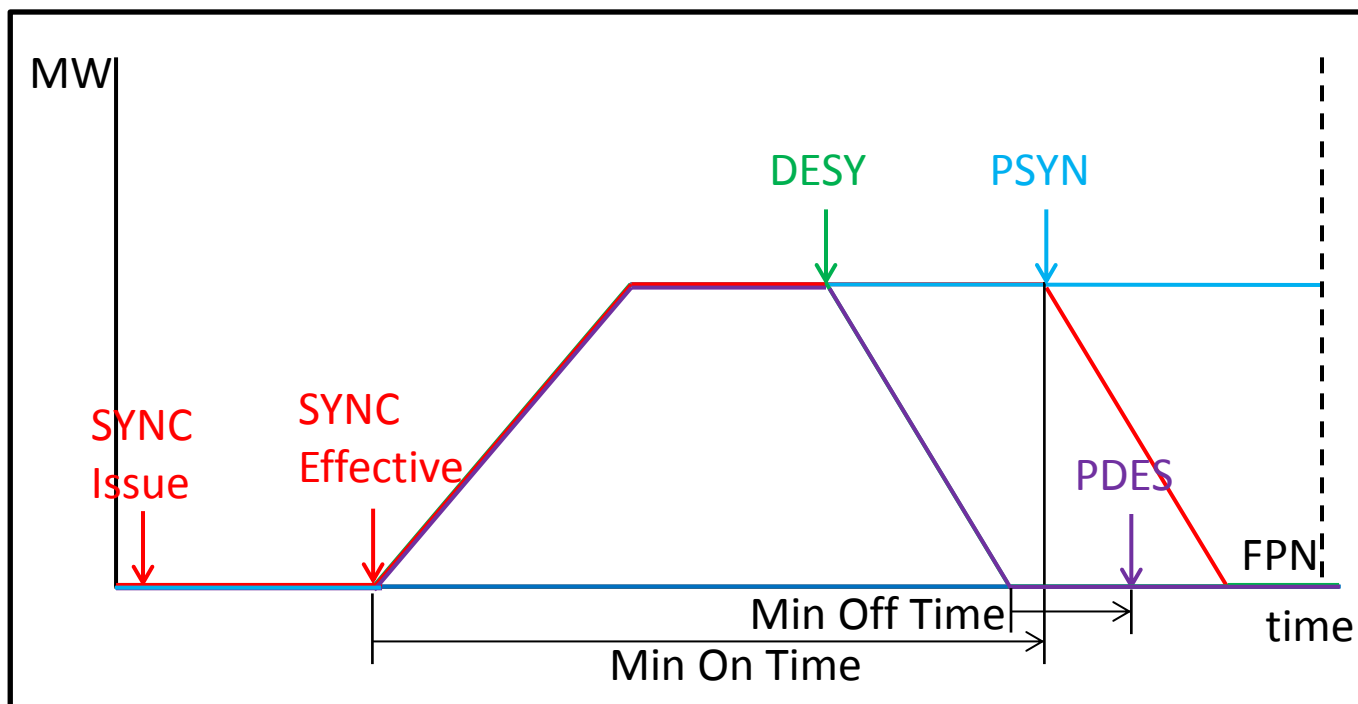

Scenario 2 – Impacted area

SYNC and DESY after MSG before Min On Time

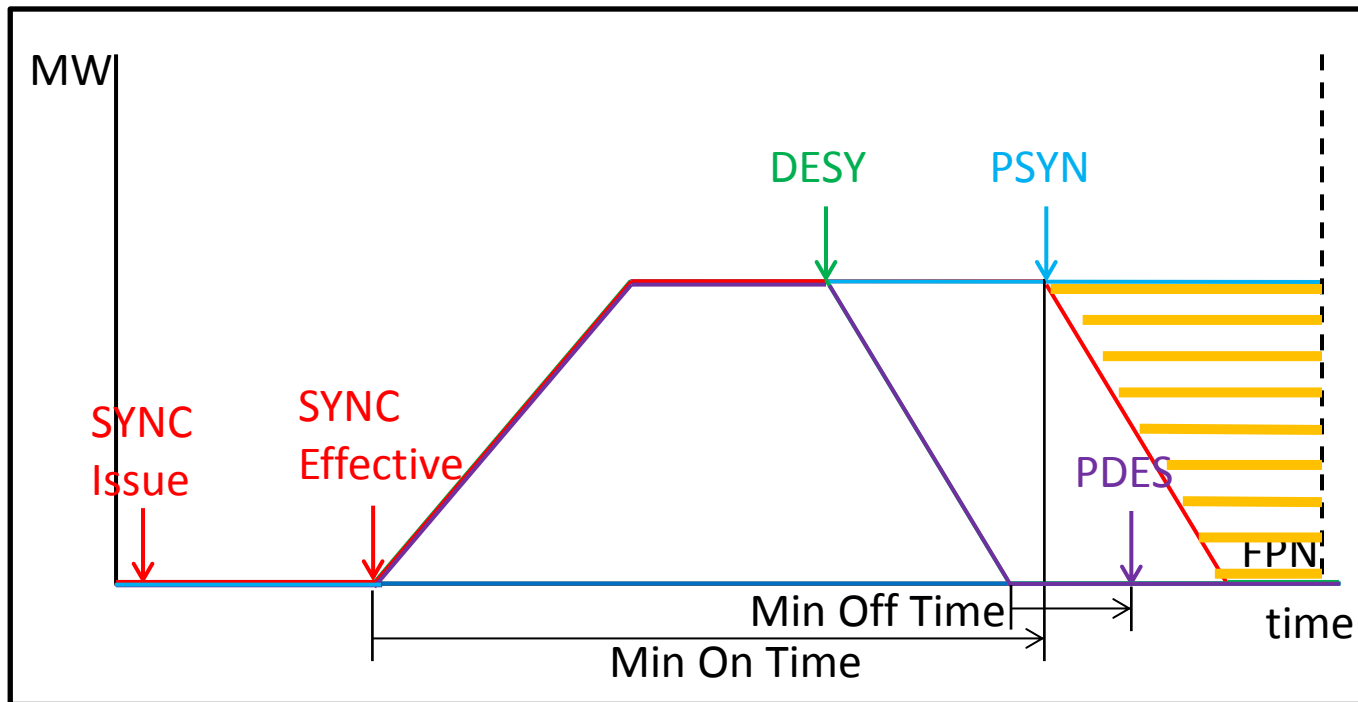

Profile will return to 'normal' after PISP (pseudo instruction at the Imbalance Settlement Period boundary) which will close off Pseudo Instructions

Scenario 2 - MOD_20_21 Proposed Legal Drafting

- Additional paragraph in the PSYN definition **Appendix O.16 Table 3**
 - If a subsequent DESY Dispatch Instruction has an Instruction Effective Time which is between the Instruction Effective Time of a prior SYNC Dispatch Instruction and the Instruction Effective Time of the corresponding PSYN Pseudo Dispatch Instruction that would nominally be created, but after the time when the Physical Notification Instruction Profile for the SYNC Dispatch Instruction reaches the Registered Minimum Stable Generation, then the PSYN Pseudo Dispatch Instruction that would nominally be created for the corresponding SYNC Dispatch Instruction shall be created.

Scenario 2 - MOD_20_21 correction for FRR

- Please note that an error in the Modification form shows changes referring to Appendix O.14 table 1:
14. How the Instruction Codes and Instruction Combination Codes are used for the calculation of Physical Notification Instruction Profiles is described in Table 1.

While the paragraph on PSYN definition actually belongs to **Appendix O.16 table 3:**

16. A Pseudo Dispatch Instruction shall not be created for a corresponding Dispatch Instruction where the System Operator issues a subsequent Dispatch Instruction with Instruction Effective Time at or before the time at which the first Target Instruction Level is reached.

Subset of Undo Scenarios - Summary

- Scenario 1 **'SYNC with MWOFF undo to level below MSG before reaching MSG'**
- Change to the system pending detailed impact assessment (grouped with Scenario 4):
 - 7 cases identified since Oct 2019 – 1 in 2019, 3 in 2020 and 3 in 2021
 - one case of high materiality (approx. 800K) in 2020 all others low materiality but 2 unknown due to no IP profile
- Scenario 2 **'SYNC with DESY after MSG but before reaching Min On Time'**
- Modification to the Code (Mod_20_21) to align with the system:
 - No cases identified since go live – not material
- **Scenario 3 'DESY with SYNC after reaching zero before Min Off Time'**
- Change to the system pending detailed Impact assessment:
 - 7 cases identified since go live - 1 in 2018, 1 in 2019, and 5 in 2021
 - Materiality vary from >100€ to approximately 200K
- Scenario 4 **'SYNC with DESY before reaching MSG'**
- Change to the system pending detailed impact assessment (grouped with Scenario 1):
 - 2 case identified in 2018 and none since
 - Materiality of 190K and 580K

Scenario 3 – Intention of rules

DESY and SYNC after zero before Min Off Time

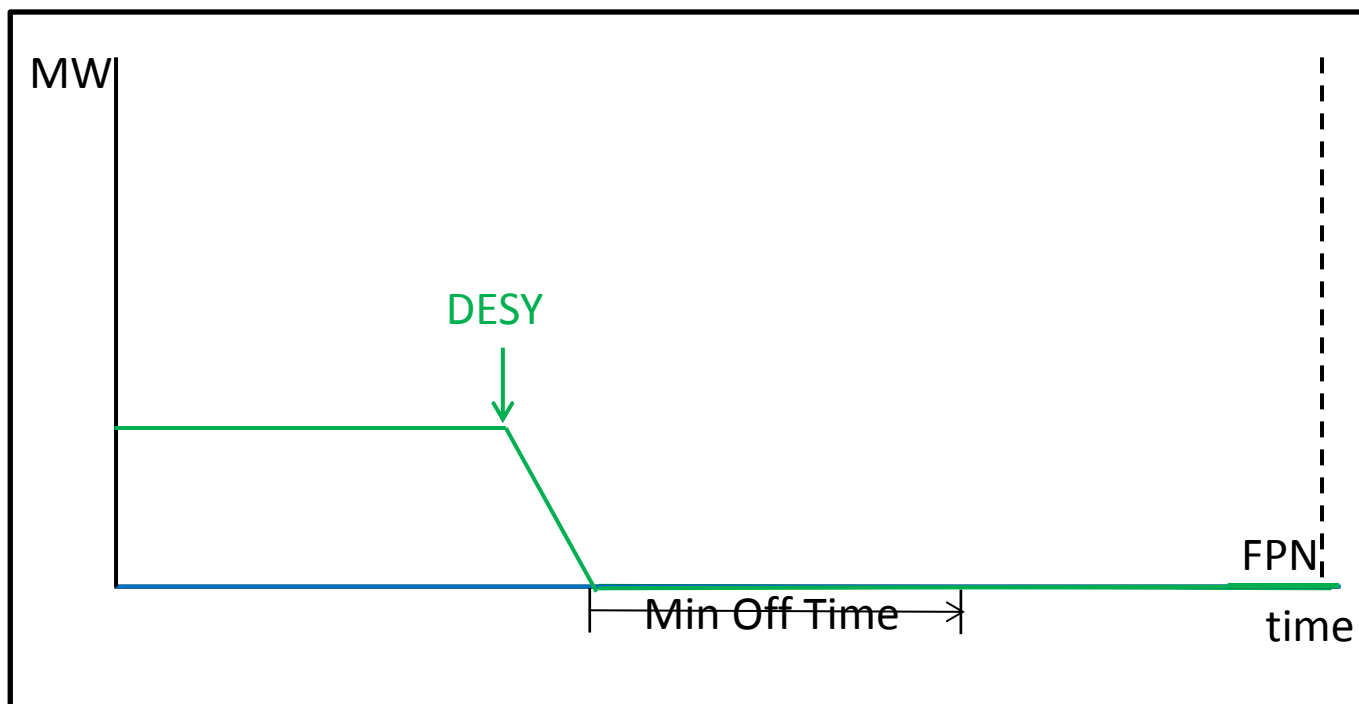

Scenario 3 – Intention of rules

DESY and SYNC after zero before Min Off Time

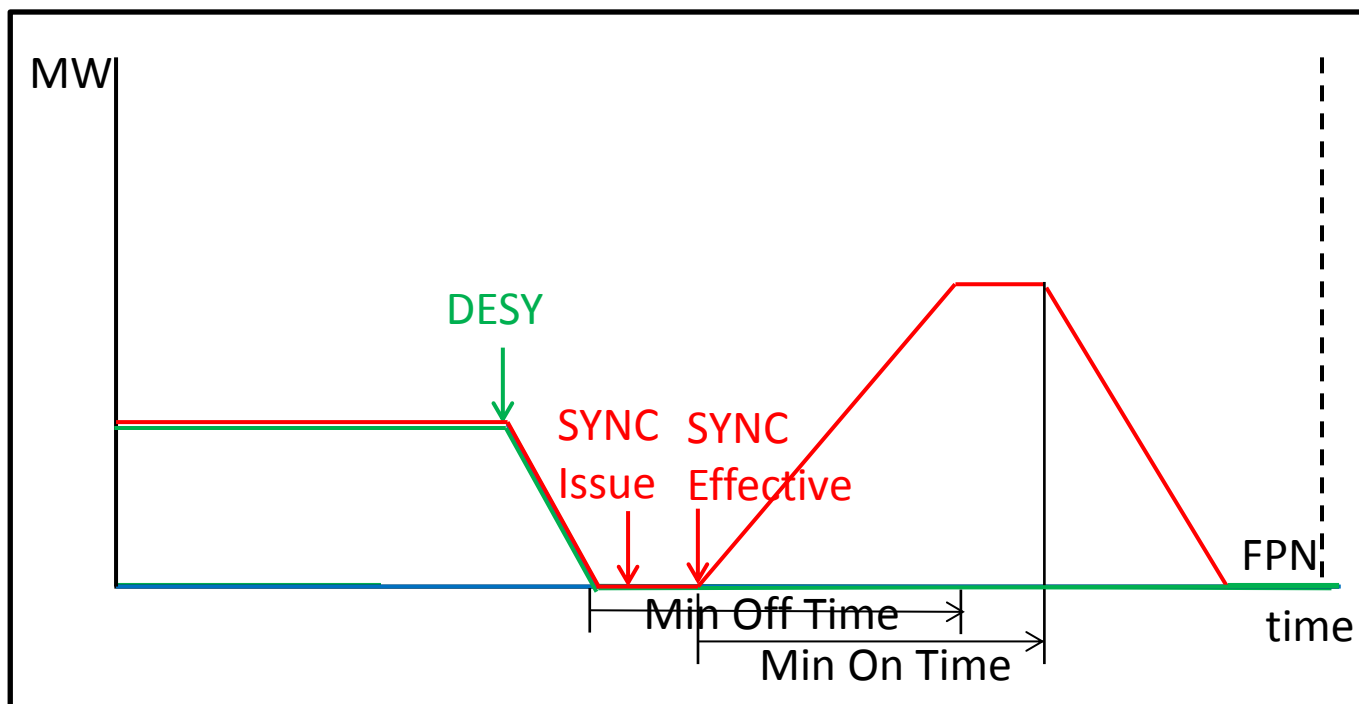

Scenario 3 – Intention of rules

DESY and SYNC after zero before Min Off Time

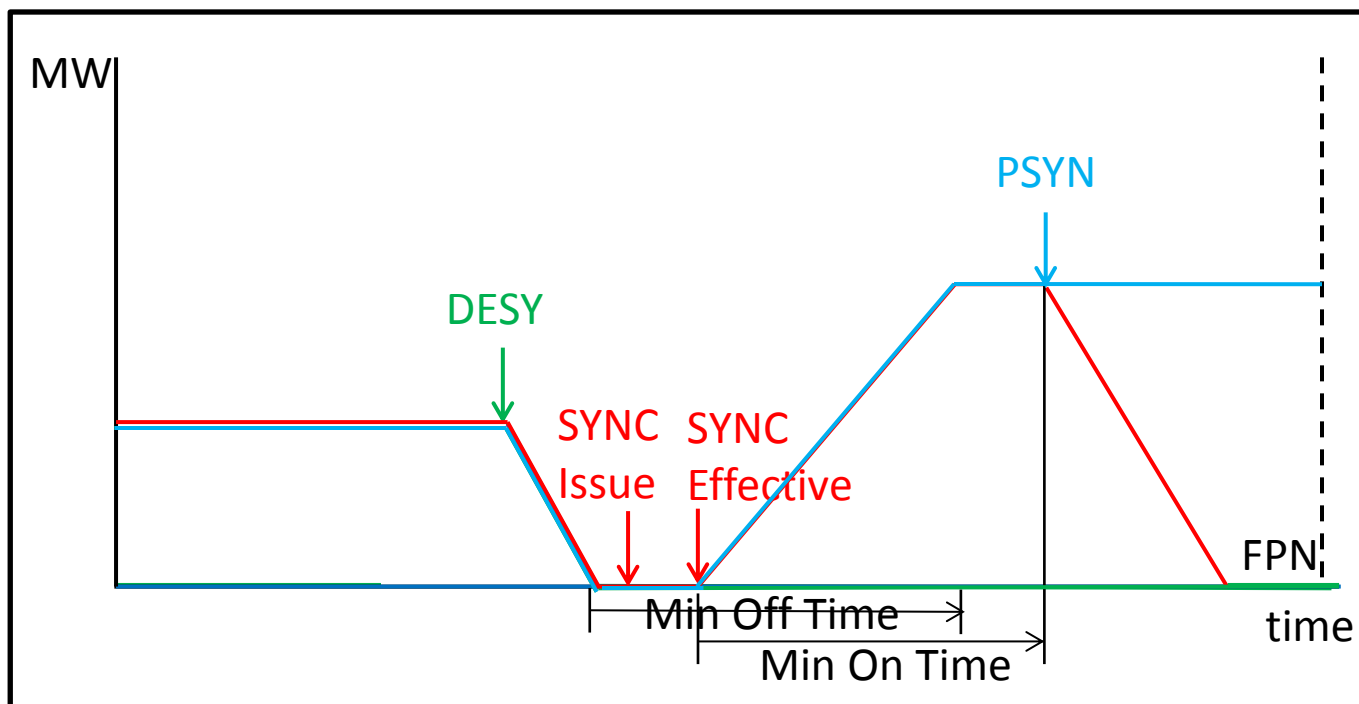

Scenario 3 – Happening in systems

DESY and SYNC after zero before Min Off Time

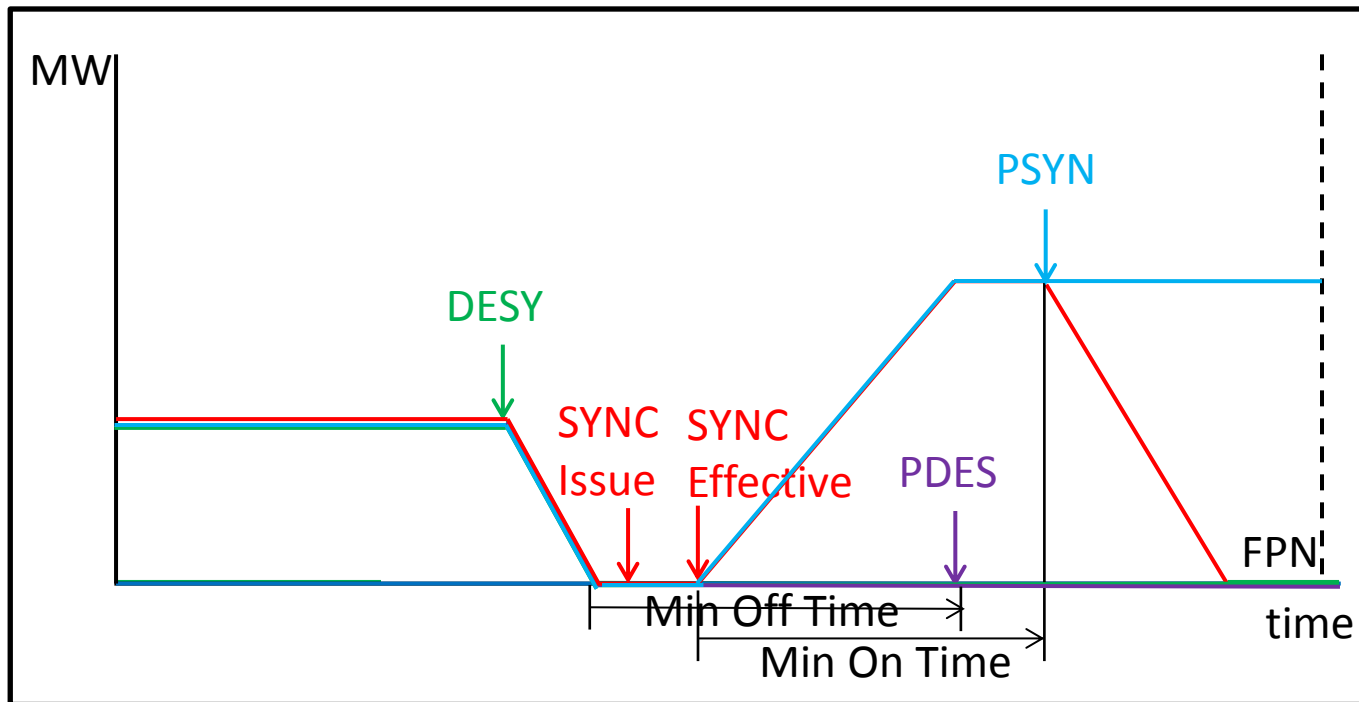

Scenario 3 – Impacted area

DESY and SYNC after zero before Min Off Time

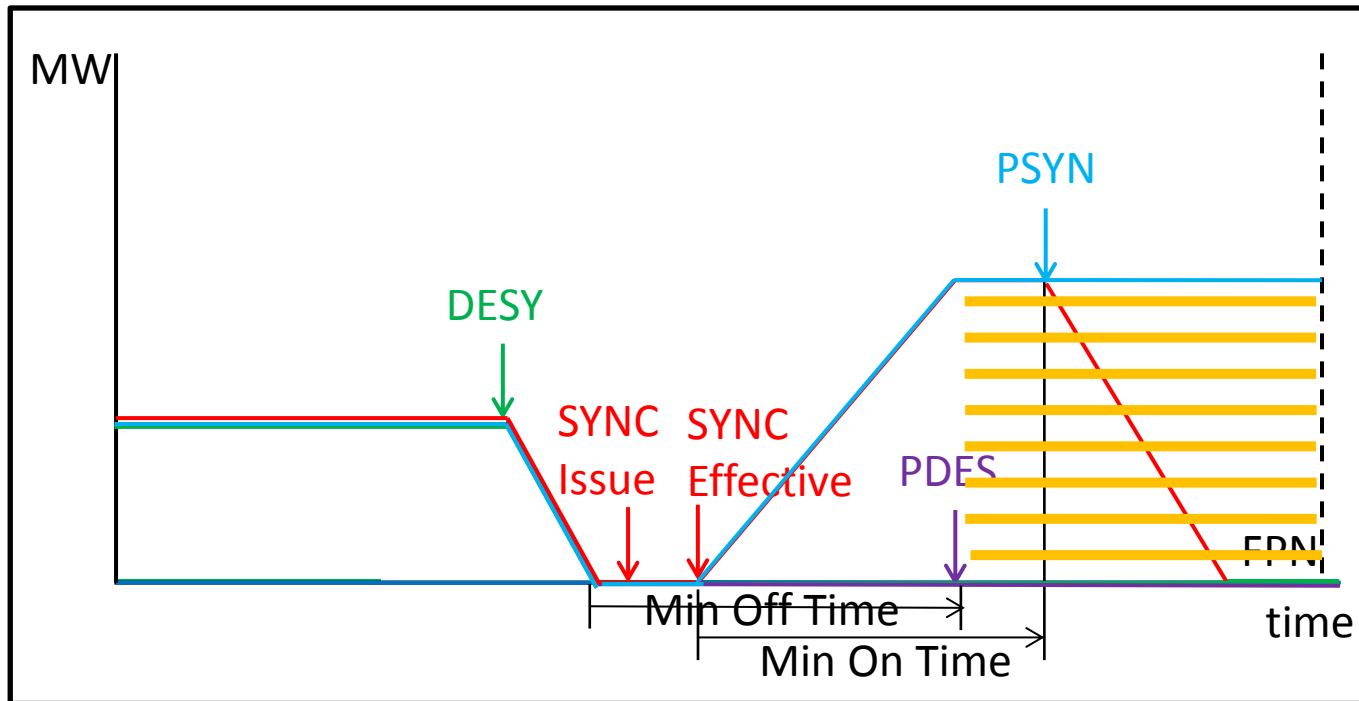

Profile will return to 'normal' after PISP (pseudo instruction at the Imbalance Settlement Period boundary) which will close off Pseudo Instructions

Subset of Undo Scenarios – Summary of proposed approach

- SEMO propose 1 Modification to the T&SC and 3 system changes;
- Scenario 4 could be considered a subset requirement of Scenario 1 (subject to vendor approval);
- Until receiving vendor approval of the above, Mod_21_21 should be put on hold;
- Given the high level assessment, SEMO deem more beneficial a change the T&SC for Scenario 2 as it is the least impacting of the 4;
- The earliest implementation is Release K – spring 2023;
- Precedence to be given to bundled Scenarios 1 and 4;
- Resettlement back to 2018 only for existing upheld queries;
- The remaining period to be covered in scheduled M+4/13.

Subset of Undo Scenarios – Alternative approaches

- All scenarios should require detailed Impact Assessment regardless of cost;
- All scenarios should require Modifications to the T&SC and no changes to the systems ;
- Both T&SC and system could be left unchanged with a regulatory acknowledgement of the non-compliance;
- Proposed changes to the T&SC could be made to Chapter H instead of Appendix O to maintain the original intent;
- Changes to the system could be implemented but applied only from an agreed cut off point;
- Others?